

Art.no 482-68,482-69

FIRST USE

STEP 1.

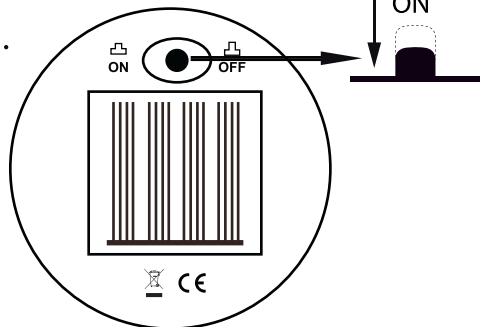

STEP 2.

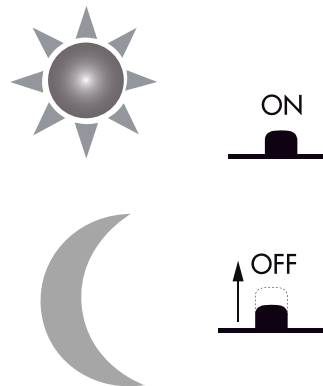

Ready after
36 h in the sun

BATTERY REPLACEMENT

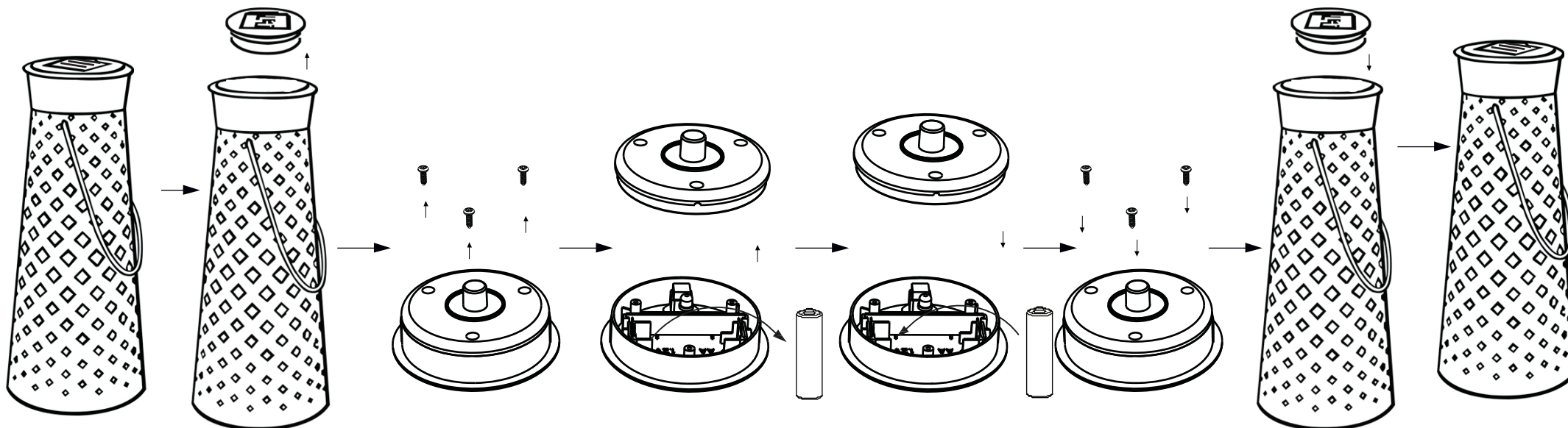

STAR[®]
TRADING
STAR STREET 1
512 50 SVENLJUNGA
SWEDEN
www.startrading.com